

B02

CERNIERA BAROCCO 2P D13 H92 L36
HINGE BAROQUE 2P D13 H92 L36

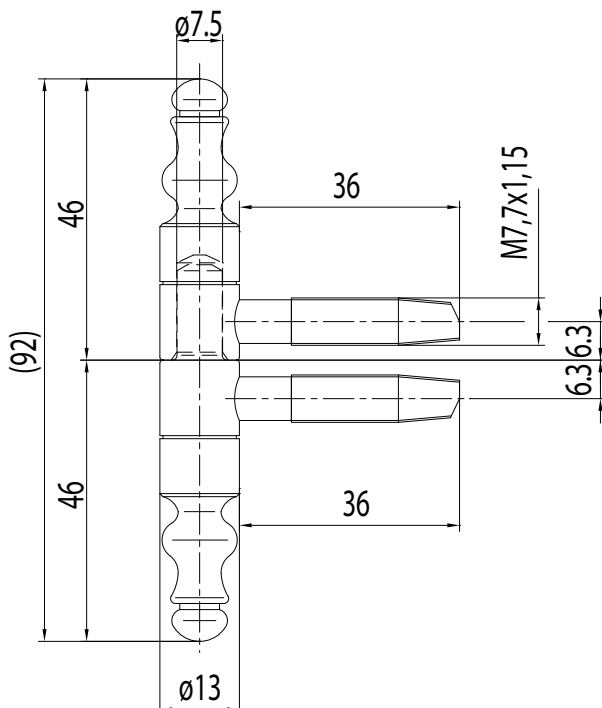

CARATTERISTICHE / FEATURES

Cerniere a vite barocco a 2 perni tipo anuba diametro 13 mm per porte e finestre in legno per applicazioni a battente e a filo.

Two baroque pins screw-in hinges Anuba type diameter 13 mm for timber doors and windows for rebated or flush application.

PORTATA MAX LOAD	Ø CORPO Ø BODY.	H. CORPO L. GAMBI BODY H - STEMS L	Ø GAMBI Ø STEMS	REGOLABILE ADJUSTABLE	MATERIALE MATERIAL
45 Kg 3 cerniere 3 hinges	13 mm	92 mm 36 mm	7 mm	NO	Acciaio Steel

FINITURE / FINISHINGS

Nichelato lucido
Polished nickel

Ottonato
Brass